

AWS GOOGLE AWS  
Azure  
AWS 4TB VMware  
WEB  
ONF  
360 2017  
10  
360  
CNCF Notary The Update  
Framework Datadog CIR-O 1.0  
Kubernetes OCI DockerCon2017 Euro Docker  
Swarm Kubernetes  
NetBSD, OpenBSD

BGP

SIDR

10

8 IPO

ForeScout 10

IPO

IPO

1 8

---

2000

IT

Skybox Security

CVC Capital Partners

Pantheon

1.5

+

---

<b>I.</b>	<b>AWS</b>	
1.1	AWS	.....1
1.2	AWS	

<b>2.</b>	<b>Easystack</b>		
<b>3.</b>	<b>99CLOUD</b>		
3.1	ONF	,	SDN .....7
<b>1.</b>			
1.1	VMware	NSX	.....8
<b>2.</b>			
<b>3.</b>			
3.1			.....8
3.2			.....9
<b>4.</b>	<b>360</b>		
4.1	360	2017	.....9
4.2	360		.....10
<b>5.</b>			
5.1			.....10
5.2			.....10
5.3	2017		.....10
<b>6.</b>			
<b>7.</b>	<b>Fortinet</b>		
7.1	Fortinet	NSS	.....11
7.2	Fortinet		.....11
7.3	Fortinet	Oracle	FortiGate .....12
<b>8.</b>	<b>Checkpoint</b>		
<b>1.</b>	<b>CNCF</b>	<b>Notary</b>	<b>The Update Framework</b>
<b>2.</b>	<b>Datadog</b>		
<b>3.</b>	<b>CRI-O 1.0</b>		
<b>4.</b>	<b>Docker</b>	<b>Swarm</b>	<b>Kubernetes</b>
<b>1.</b>			
<b>2.</b>			
<b>3.</b>	<b>NetBSD, OpenBSD</b>		
<b>4.</b>	<b>SIDR</b>		<b>BGP</b>
<b>1.</b>	<b>IPO</b>		
1.1	ForeScout Technologies IPO		.....16

**2.**

2.1	Skybox Security	1.5		.....	16
2.2	KnowBe4,LLC	3000	B	.....	16
2.3	CrowdStrike	2500	D	.....	16
2.4	Duo Security	7000	D	10 .....	17
2.5	SecurityScorecard Inc.	2750	C	.....	17
2.6	Attivo Networks	2100	C	.....	17
2.7	Contrast Security	3000	C	.....	17

+

# 1. AWS

## 1.1 AWS

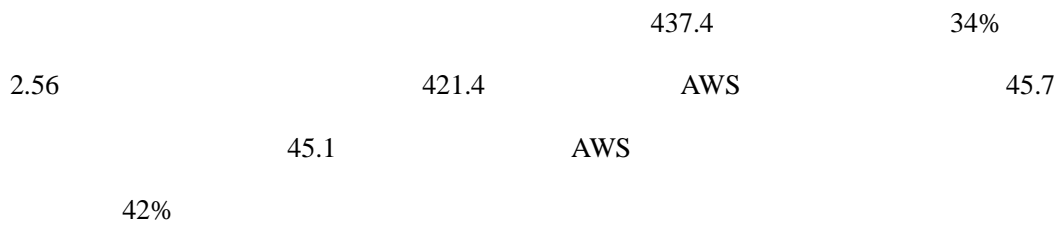

## 1.2 AWS

## 5G IoT

- AWS 5G IoT
- AWS
- Nuage Network SD-WAN
- AWS 5G AWS
- AWS Greengrass MEC
- IMPACT
- AWS 6 Greengrass AWS
- AWS Lambda

### 1.3 Salesforce AWS

Salesforce AWS 3 Salesforce  
Salesforce Salesforce  
Salesforce AWS Telstra  
Salesforce AWS Salesforce

### 1.4 AWS 4TB

AWS EC2 x1e.32xlarge EC2 4TB  
DDR4 Intel Xeion E7 8880 v3 Haswell 2.3GHz 128 vCPU L3  
AWS 25Gbps  
x1e.32xlarge AWS 1. 2.  
3. 4.  
Azure 2TB Google 416GB AWS  
26.688  
38.688

## 2. VMware

### 2.1 VMware

VMware VMware vCloud Air Network  
VCAN vCAN  
vCAN vCAN

### 2.2 VMware F5

VMWARE F5

2.3 **VMware NSX**

2017 10 24 VMWARE NSX

(vNIC) NSX (DFW)

DFW

DFW ESXi vSSM

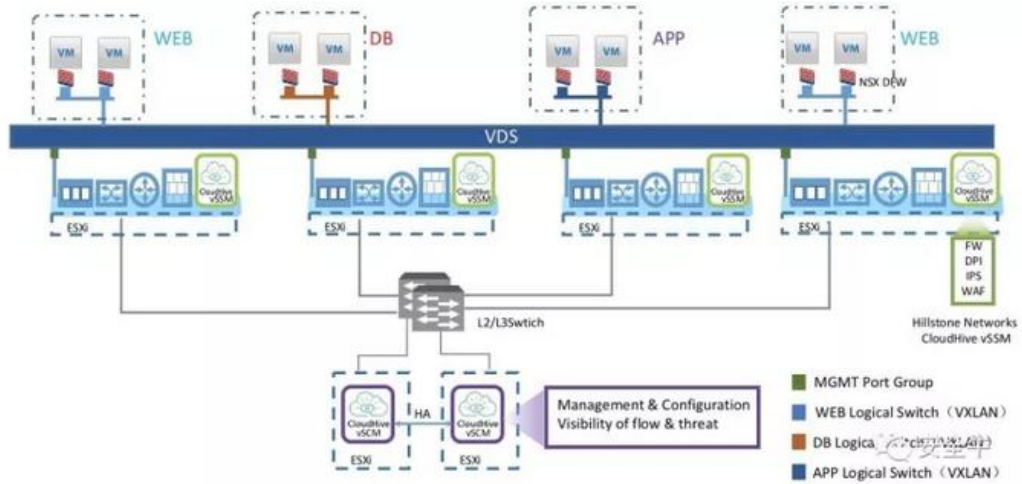

### 3. GOOGLE

3.1

Google

Google

Google

Kubernetes

Istio API

Apigee

Google Cloud Platform

runtime

3.2

**Alphabet**

Alphabet

Alphabet

277.72

224.51

24% Alphabet

67.32

50.61

33%

Google other

34.05

40%

30.9

42%

15%

#### 4. Azure

##### 4.1 204

2017 9 30 2018  
245 12% 66 16%

204

Office 365 commercial, Azure, Dynamics 365,

Office 365 commercial

42% Dynamics 365 69% Azure 90%

Azure 90%

Azure 93% 93% 97% 90%

##### 4.2 Azure AWS

Cloud Services Map

Azure AWS

RightScale 2017 1.8

##### 4.3

Predix

Azure

##### 4.4 Azure

Government Cloud Forum 2017 Azure

Government Secret

Government Cloud

blockchain-as-a-service

6

FedRAMP

4.5

**15**

15

37

CountyKerry

4.6

**Cray**

Cray

Cray

Azure

/

/

4.7

**Azure**

**OpenBSD**

OpenBSD 6.1

OpenBSD

UNIX

OpenBSD

**5.**

5.1

**NVIDIA**

NVIDIA

DLI

NVIDIA GPU

NVIDIA

5.2

**Link**

2017

Link

Link

ICA

5.3

2017

**6.**

6.1

IT

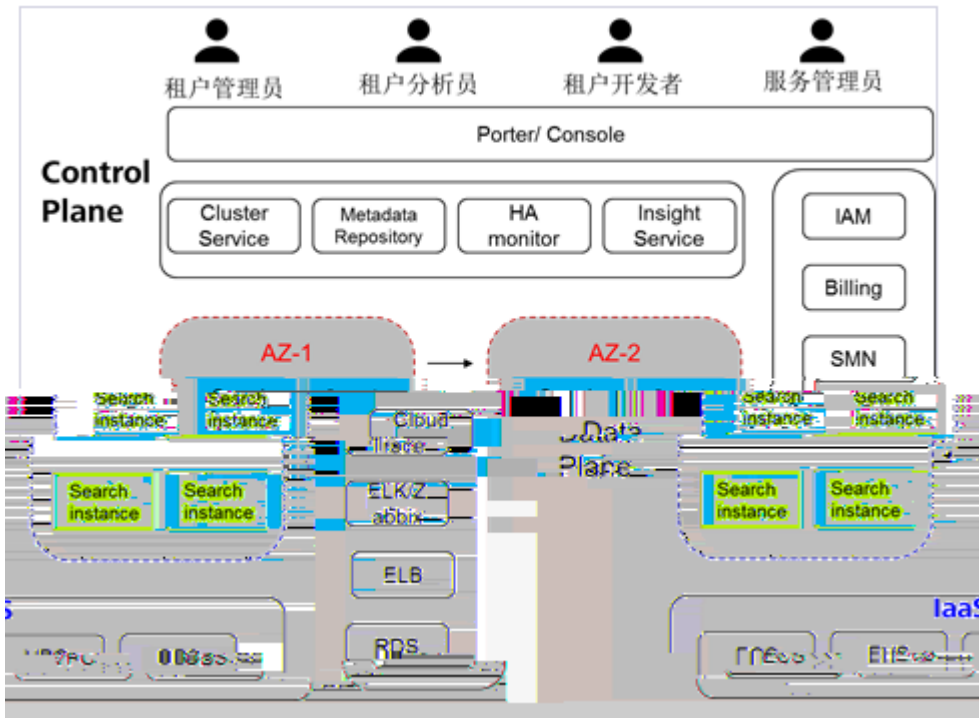

7.3

2017 10 23

## 1. Openstack

## 2. Easystack

## 3. 99CLOUD

3.1 ONF , SDN

(Open Networking Foundation) ONF

OPENCORD

Linux

CNCF

SDN

SDN

# **1.**

1.1

**VMware**

**NSX**

## NSFOCUS TVM

3.2

400G B      20T B      10      vCPU      320



**4. 360**

4.1 360

2017

8

2017

11 12

360

360

4.2 **360**

360

360

360

360

360

**5.**

5.1

Data Security Maturity Model

DSMM

5.2

10

14

17

5.3

**2017**

2017

2.0

## 6.

## 7. Fortinet

### 7.1 Fortinet

### NSS

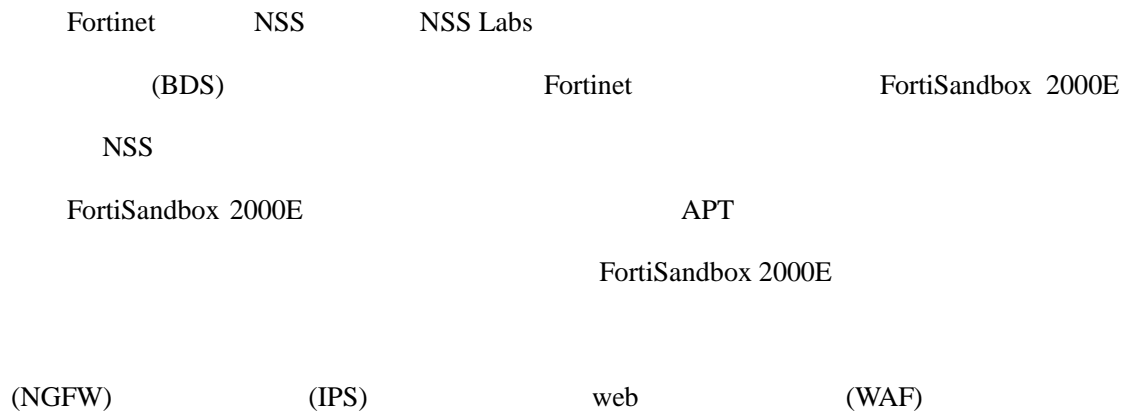

### 7.2 Fortinet

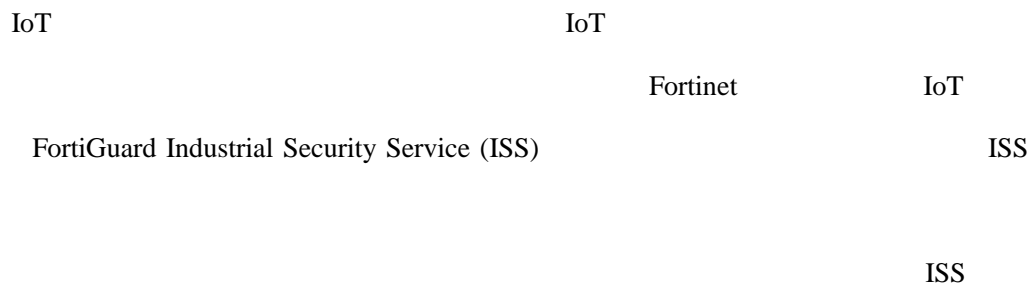

Fortinet

FortiOS

FortiGate FortiSIEM Secure Access FortiGuard Threat Intelligence Advanced Threat Protection

### 7.3 Fortinet Oracle FortiGate

Fortinet Oracle Partner Network(OPN) FortiGate (VM)

Oracle

FortiGate (VM) BYOL Oracle Cloud

FortiGate (VM)

## 8. Checkpoint

### 1. CNCF Notary The Update Framework

CNCF Notary The Update Framework Notary

### 2. Datadog

Datadog

CPU I/O

2

Docker Kubernetes AWS ECS



**1.**

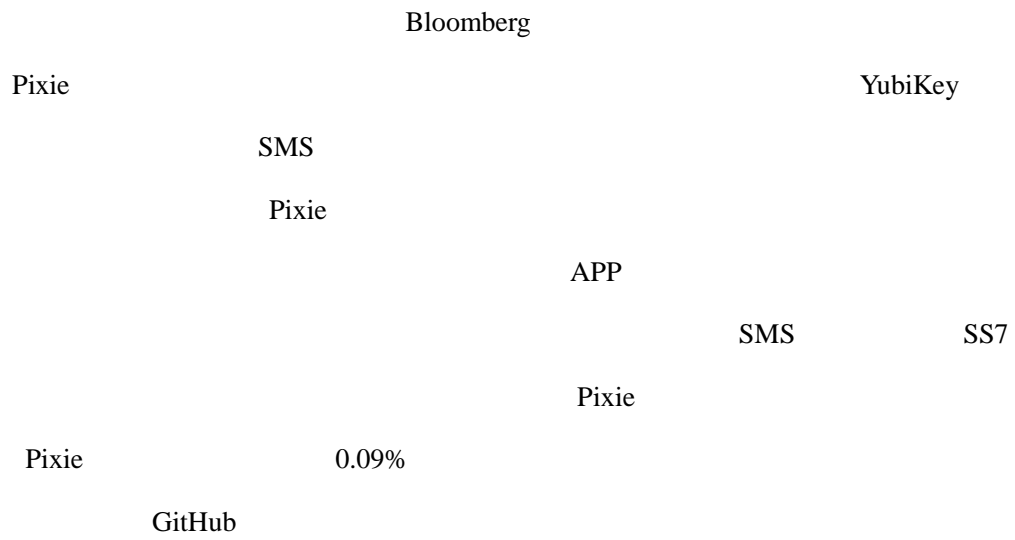

**2.**

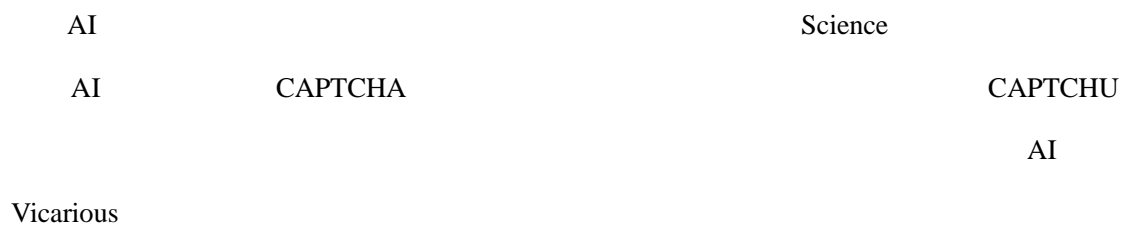

### 3. NetBSD, OpenBSD

NetBSD 64 AMD ASLR KASLR  
NetBSD  
Maxime Villard bootloader  
kernel prekernel OpenBSD KARL

### 4. SIDR BGP

SIDR SIDR  
Border Gateway Protocol  
20 80  
BGP  
IETF  
IETF  
SIDR RPKI  
BGP Origin  
RPKI BGP BGP  
BGP BGPsec IETF RFC 8205 8210

## 1. IPO

### 1.1 ForeScout Technologies IPO

10 26 ForeScout Technologies Inc  
 IPO \$116,000,000 1.20  
 ForeScout 300  
 CounterACT  
 500

## 2.

### 2.1 Skybox Security 1.5

10 25 IT Skybox Security CVC Capital Partners  
 Pantheon \$150,000,000 Skybox Security  
 IT  
 90

### 2.2 KnowBe4,LLC 3000 B

10 24 KnowBe4,LLC Goldman Sachs Elephant \$30,000,000 B  
 KNOWBE4

### 2.3 CrowdStrike 2500 D

10 19 CrowdStrike \$25,000,000 D CrowdStrike  
 McAfee CTO George Kurtz Dimitri  
 Alperovitch 2011 Irvine Falcon

**2.4 Duo Security 7000 D 10**

10 18 Duo Security Lead Edge Capital 6 \$70,000,000  
 D Duo Security  
 iOS

**2.5 SecurityScorecard Inc. 2750 C**

10 12 SecurityScorecard Inc. Nokia Growth Partners (NGP) 8  
 \$27,500,000 C SecurityScorecard

**2.6 Attivo Networks 2100 C**

10 11 2.6 Attivo Networks facebook customer service phone number 2  
 \$21,000,000 C Attivo Networks

SCADA

**2.7 Contrast Security 3000 C**

10 19 Contrast Security General Catalyst 2 \$30,000,000  
 C Contrast Security